

The logo for HydroMet, featuring a white diagonal slash followed by the text "HydroMet" in a bold, white, sans-serif font.

/ HydroMet

User Manual

TB7

The KISTERS logo, consisting of a white stylized 'K' symbol followed by the word "KISTERS" in a bold, white, sans-serif font. Below the logo is the tagline "Empowering decisions of tomorrow" in a smaller, white, sans-serif font.

KISTERS
Empowering decisions of tomorrow

Table of Contents

I	Disclaimer	3
II	Scope of Delivery	4
III	Safety Instructions	5
Part I	Introduction	6
Part II	Installation	7
2.1	Unpacking your TB7 Rain Gauge	7
2.2	Site Selection and Setup	7
2.3	Quick Instruction	7
Part III	Configuration	12
3.1	Calibration	12
Part IV	Operation	13
4.1	Test Operation	13
4.2	Electrical	13
Part V	Maintenance	14
Part VI	Troubleshooting	16
Part VII	Repair	18
7.1	TB7 Part List	18
Part VIII	Technical Data	23
Part IX	Obligations of the Operator and Disposal	24
9.1	Obligations of the Operator	24
9.2	Dismantling / Disposal	24

I Disclaimer

The information provided in this manual was deemed accurate as of the publication date. However, updates to this information may have occurred.

This manual does not include all of the details of design, production, or variation of the equipment nor does it cover every possible situation which may arise during installation, operation or maintenance. KISTERS shall not be liable for any incidental, indirect, special or consequential damages whatsoever arising out of or related to this documentation and the information contained in it, even if KISTERS has been advised of the possibility of such damages.

Any errors found in any KISTERS product should be reported to KISTERS where every effort will be made to quickly resolve the problem.

Copyright Notice: No parts of this work may be reproduced in any form or by any means without the written permission of the publisher. KISTERS waives copyright for users to print out parts of the documentation in hard copy for their own use only.

Trademark Notice: KISTERS products and services referred to in this document are trademarks or registered trademarks of KISTERS. Other product names used may or may not be the trademarks of their respective owners.

© 2026 | KISTERS. Any rights not expressly granted herein are reserved.

II Scope of Delivery

- TB7 Rain Gauge
- 5 metre connecting lead (TB311)
- Bird Spikes with Quick Instruction
- Allen Key

III Safety Instructions

- Read the user manual including all operating instructions prior to installing, connecting and powering up the KISTERS TB7. The manual provides information on how to operate the product. The manual is intended to be used by qualified personnel, i.e. personnel that have been adequately trained, are sufficiently familiar with installation, mounting, wiring, powering up and operation of the product.
- Keep the user manual on hand for later reference!
- If you encounter problems understanding the information in the manual (or part thereof), please consult the manufacturer or its appointed reseller for further support.
- KISTERS TB7 is intended to be used in hydrometeorological or environmental monitoring applications.
- Before starting to work, you have to check the functioning and integrity of the system.
 - Check for visible defects on the TB7, this may or may not include any or all of the following: mounting facilities, connectors and connections, mechanical parts, internal or external communication devices, power supplies or power supply lines, etc.
 - If defects are identified that could compromise operational safety, work must be stopped immediately. This applies to defects detected both before work begins and during operation.
- Do not use the KISTERS TB7 in areas where there is a danger of explosion.
- The present user manual specifies environmental/climatic operating conditions as well as mechanical and electrical conditions. Installation, wiring, powering up and operating the KISTERS TB7 must strictly comply with these specifications.
- Perform maintenance only when tools or machinery are not in operation.
- If guards are removed to perform maintenance, replace them immediately after servicing.
- Never make any electrical or mechanical diagnostics, inspections or repairs under any circumstances. Return the product to the manufacturer's named repair centre. You can find information on how to return items for repair in the relevant section of the KISTERS website.



Disposal instructions: After taking the KISTERS TB7 out of service, it must be disposed of in compliance with local waste and environmental regulations. The KISTERS TB7 is never to be disposed of in household waste!



Inputs and outputs of the device are protected against electric discharges and surges (so-called ESD). Do not touch any part of the electronic components! If you need to touch any part, please discharge yourself, i.e. by touching grounded metal parts.

1 Introduction

Thank you for choosing our product. We hope you will enjoy using the device.

KISTERS manufactures, sells, installs and operates quality instrumentation, data loggers and communication technology. Products are designed with passion for environmental monitoring and with a deep understanding of the quality, accuracy and robustness needed to fulfil the requirements of measurement practitioners in the field.

The present User Manual will help you understand, install and deploy the device. If, however, you feel that a particular information is missing, incomplete or confusing, please do not hesitate to contact us for further support!

KISTERS' TB7 is a new generation high-quality tipping bucket rain gauge for measuring rainfall and precipitation in remote and unattended locations when used in conjunction with KISTERS' Undercover data logger (see flip side) or a smart communication module. TB7 is a reliable 'low cost' device with a very good accuracy across a broad range of rainfall intensities.

Key Features

Tipping Bucket Mechanism

- The TB7 uses a double-bucket system, where a bucket tips after collecting a specific volume of rain.
- The system is engineered to minimize errors caused by incomplete drainage. This is achieved through:
 - Teflon-impregnated material for the bucket, reducing surface tension.
 - Sapphire pivots that support the central axis ensure smooth bucket operation.

Measurement Resolutions

Standard 200 cm² collecting surface per WMO guidelines.



- Metric:
 - Resolutions available: **0.1 mm, 0.2 mm, 0.5 mm.**

Reed Switch

- When the bucket tips, it closes a **double-reed contact**, generating a pulse signal. Two separate reed-switch outputs can be connected to up to 2 devices for redundant collection of rain data.
- Use the supplied cable to connect the reed switch to a local data logger that will record individual pulses.
- **Important:** The reed-switch output is **not bounce-free**, meaning noise from the mechanical action could produce false signals. Proper debouncing must be implemented in the connected data logger. KISTERS iRIS data loggers come equipped with a built-in debouncing mechanism on counter/pulse inputs to address this.

2 Installation

This chapter contains the following subsections:

- [Unpacking your TB7 Rain Gauge](#) 
- [Site Selection and Setup](#) 
- [Quick Instruction](#) 

2.1 Unpacking your TB7 Rain Gauge

This package should contain:

- TB7 Rain Gauge
- 5 metre connecting lead (TB311)
- Bird Spikes with Quick Instruction
- Allen Key

Please verify you have received these items and that the Tipping Bucket Rain Gauge resolution is as ordered.

To prepare the Tipping Bucket Rain Gauge for installation:

- Lift the unit from the carton and place on a secure surface.
- Remove polythene bag.
- Using the Allen key supplied, unscrew the three enclosure fixing screws and pull them back until the screw head is clear of the enclosure.
- Lift the enclosure from the gauge.
- Carefully remove the elastic band/support pad from the bucket.

Your Tipping Bucket Rain Gauge is now ready for installation.

2.2 Site Selection and Setup

Site Selection

Rainfall measurements are intended to be representative of the actual rain falling on a given area. Some of the more important factors which influence the representativeness of a gauge are as follows:

- Install the gauge on level ground if possible. Avoid sloping sites.
- The site should have adequate protection from strong winds.
- The site should be free of large obstructions such as buildings and trees.
- Provide suitable ground surface to avoid splashing into the gauge.

Setting up

- Install the gauge on the foundation. A suggested foundation is shown in Diagram 1.
- Using the Allen key supplied, loosen the three fixing screws until the head is clear of the surface and remove the housing.
- The gauge is provided with a bull's eye level. Adjust the nuts on the mounting bolts until the gauge is level, then tighten all three nuts to secure the gauge in place.
- Connect the TB311 connecting lead to the rain gauge reed switch terminals, refer to [Diagram 7](#) , and to the recording device, in accordance with manufacturer's instructions.

2.3 Quick Instruction

Assembling Bird Spikes

1. Quantity of bird spikes supplied 24 off, 18 off to assemble and 6 off as spares.
2. When assembling please ensure the flat side of the spike is facing the funnel ring
3. Do not force the spike in - the step on the spike should sit against the flat surface on the top of the hole.

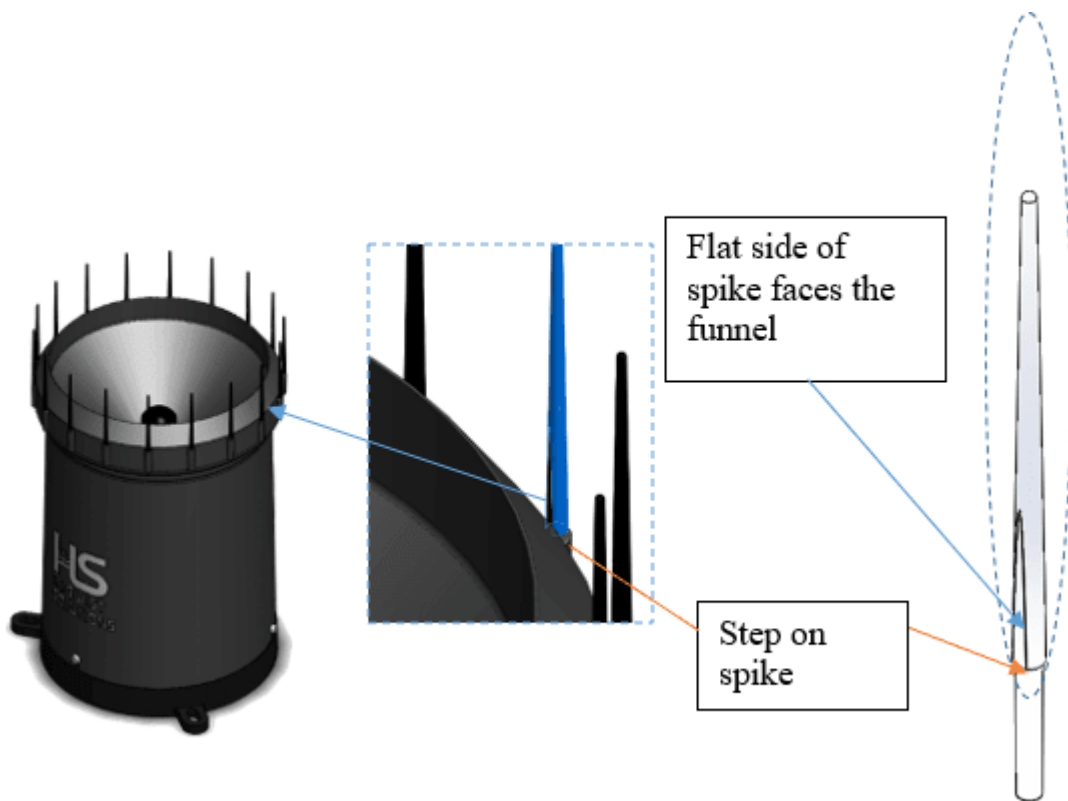

Base Instruction



Removable plug to pass the reed switch signal to an external RTU or to enter the solar cable to power the internal RTU Undercover

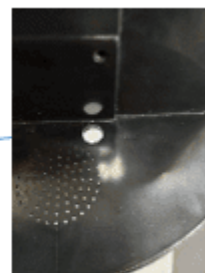

Blind hole drill 6.5 mm (1/4") Dia. to connect a panel mount SMA connector for antenna. Only for TB4 & TB6. For TB7 internal antenna can be used.



Floor Mount

*In Built Bird Guard
Part No. TB777-04*

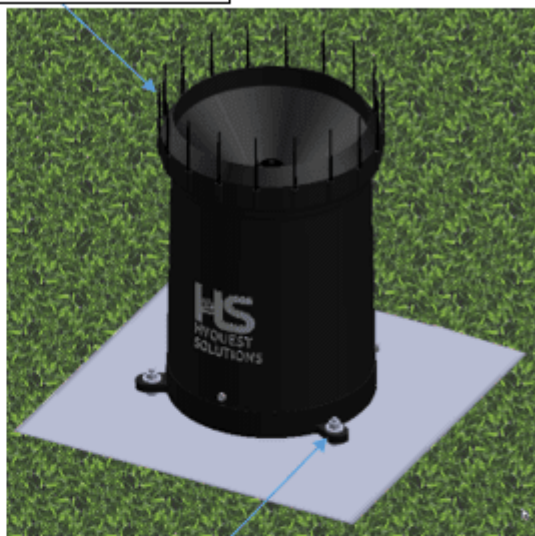
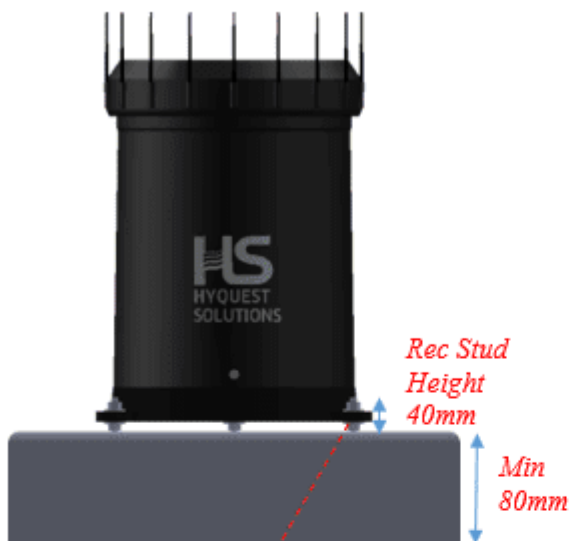

*M6 Stainless Steel Anchor Studs
(Not Supplied, required
quantities 3 off)*

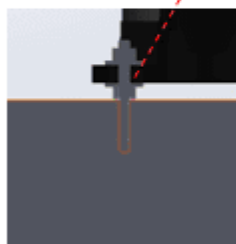

*Drill 3 x holes equispaced on a
244 Dia PCD, to suit M6
Stainless Steel Anchor Studs.*

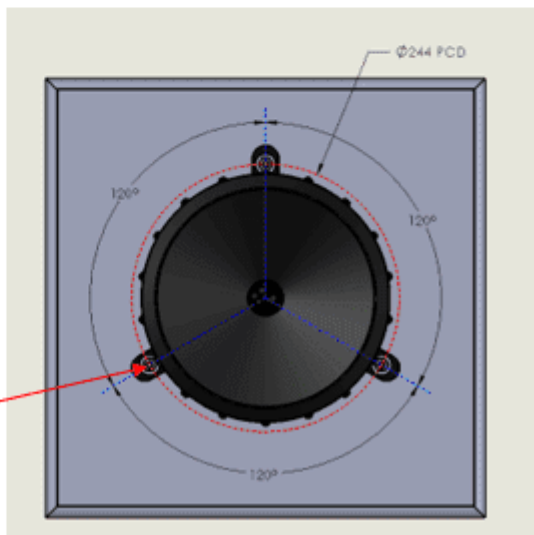

Diagram 1

Pole Mount

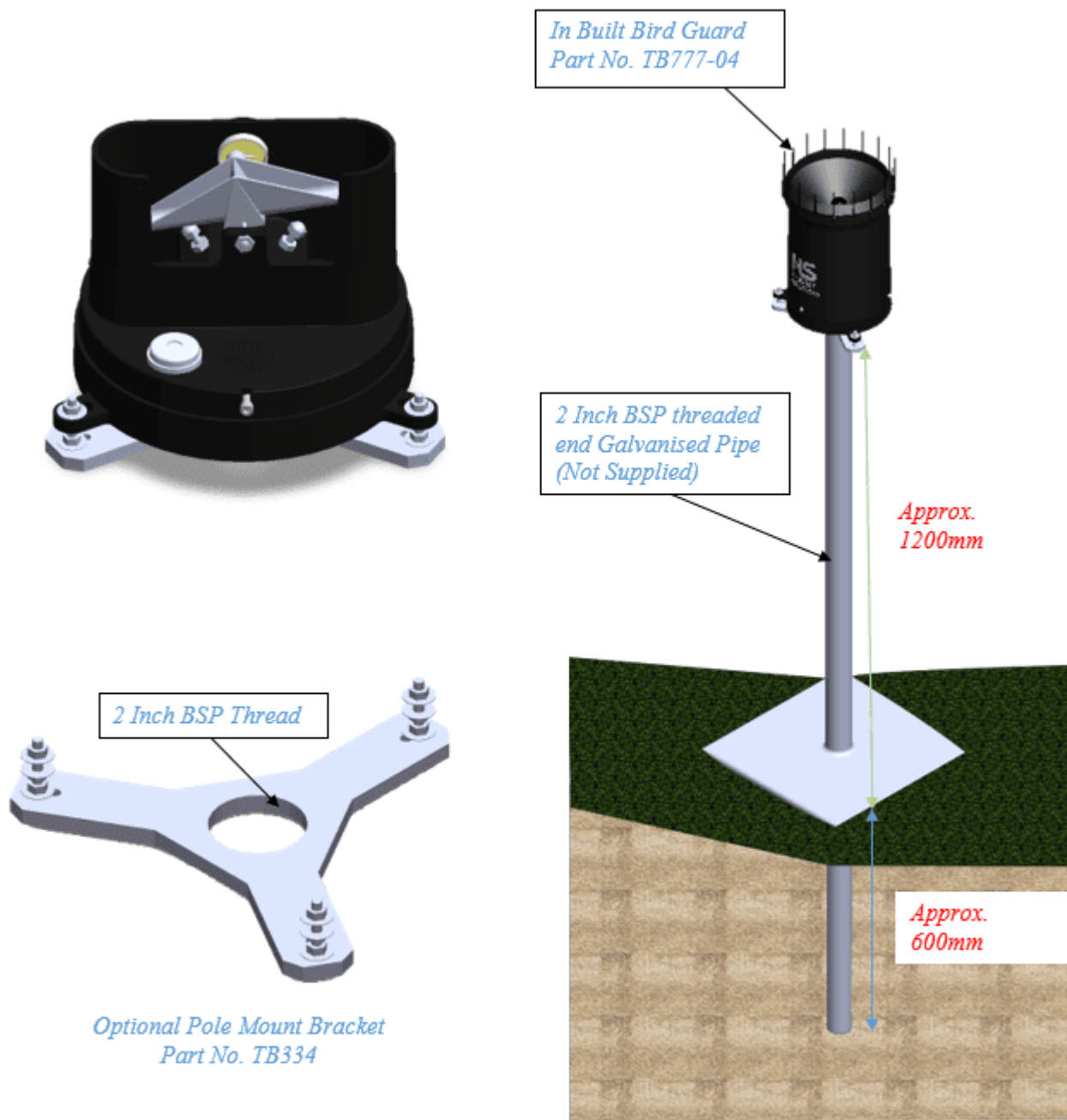

Diagram 2

Roof Mount

The Rain Gauge can also be mounted on a pitched roof with maximum angle of 15 degrees.

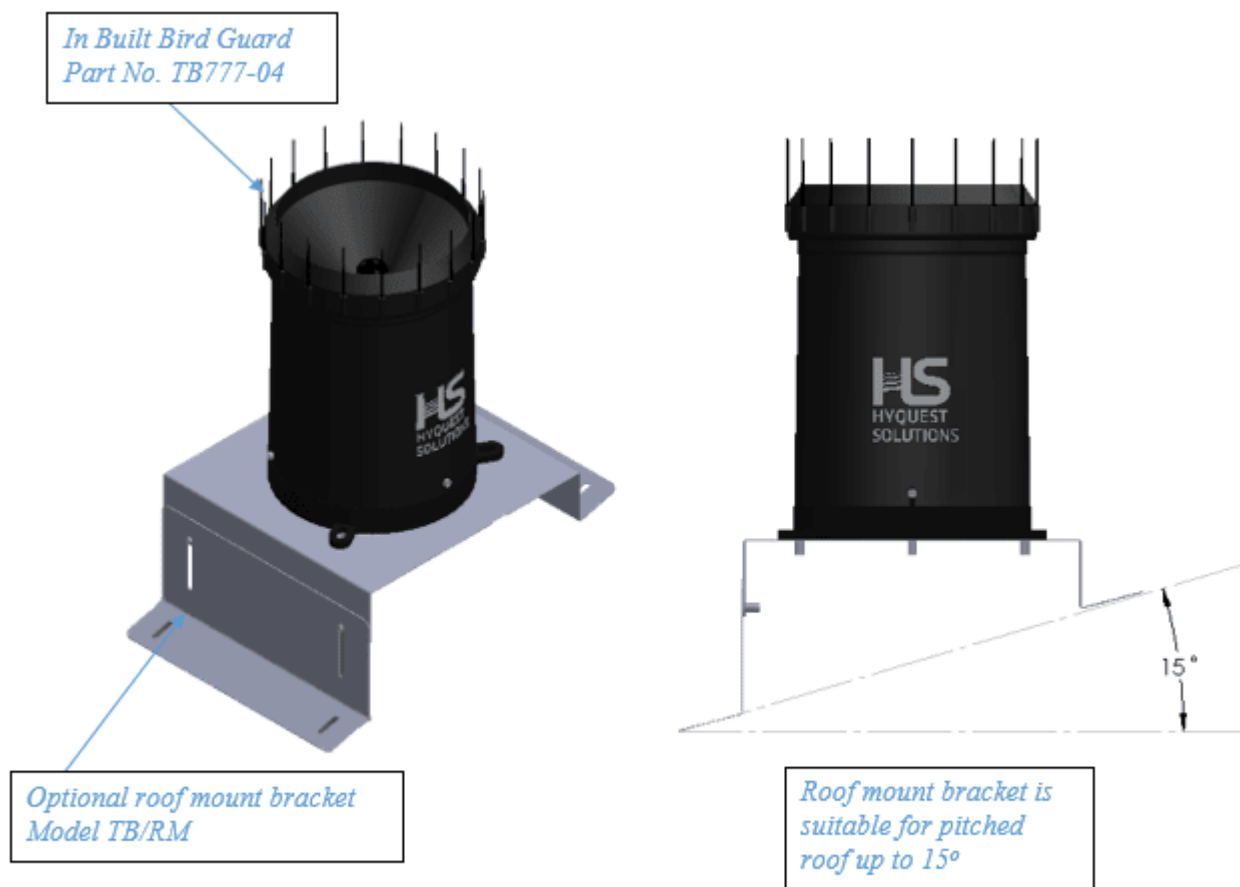

Diagram 3

3 Configuration

This chapter contains the following subsections:

- [Calibration](#) 

3.1 Calibration

The Model TB7 Tipping Bucket Rain Gauge is batch calibrated. The batch calibration process guarantees that each rain gauge supplied will work within the range of accuracy specified by KISTERS, namely “0 to 200 mm per hour: $\pm 5\%$ for 0.2 mm, 0.01” and 0.5 mm buckets, 200 - 500 mm per hour: Better than $\pm 8\%$ ” for 0.5 mm bucket only. The batch calibration process is detailed below:

- Buretting:
Each side of the tipping bucket is balanced and buretted to the practical volume applicable to the resolution of the gauge (i.e. 0.2 mm or 0.5 mm or 0.01”). The buretting is carried out with NATA calibrated and certified equipment.
- Initial Calibration:
The initial production run of 50 rain gauges are all buretted, as described in Item i) above and calibrated on our TB340A Laboratory calibrator, over a range of intensities (50 mm/hr to 500 mm/hr)
- Ongoing Calibration:
From every batch of 50 units thereafter, one gauge will be randomly selected and fully calibrated as per Item ii) above, to ensure the specified accuracy and repeatability are maintained.
On request a full calibration can be undertaken at additional cost.
Please contact either KISTERS or our local distributor for further information.

4 Operation

This chapter contains the following subsections:

- [Test Operation](#) ¹³
- [Electrical](#) ¹³

4.1 Test Operation

- Manually tip the bucket a number of times, ensuring that each tip is being recorded and that the tilting mechanism is operating freely.
- Replace and secure the enclosure.

4.2 Electrical

Dual reed switches are provided for several reasons:

- Two isolated switches permit the control of two separate circuits; e.g. a local counter and a telemetry circuit.
- Parallel connection of both switches increases the current carrying capacity of the contact system if required.
- Parallel switch operation confers a degree of redundancy in locations where data from the Rain Gauge is critical to flood warning etc.

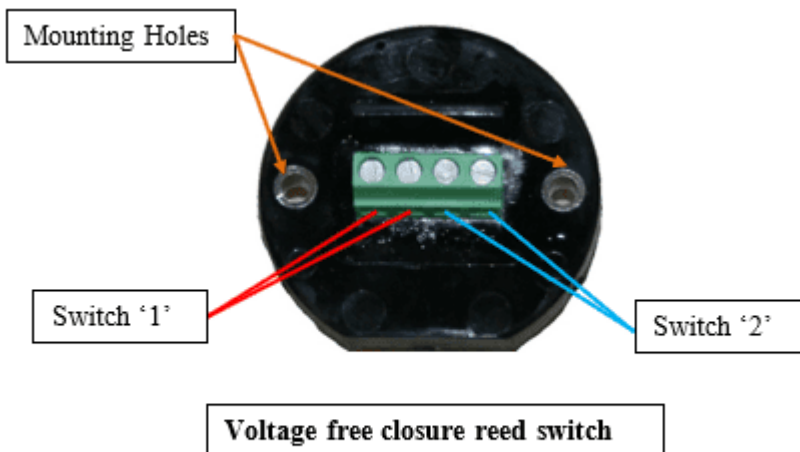

Diagram 7

5 Maintenance

The only routine maintenance required is cleaning. The following items should be checked regularly for cleanliness:

- Catch filter
- Straight through Nozzle (refer diagram 5)
- Interior of bucket
- Top surface of adjusting screws
- Enclosure locking screws - lightly lubricate after cleaning
- All insect screens

Dismantle Details

- a. Push filter in and pull straight through Nozzle out
- b. Clean filter
- c. Clean straight through nozzle

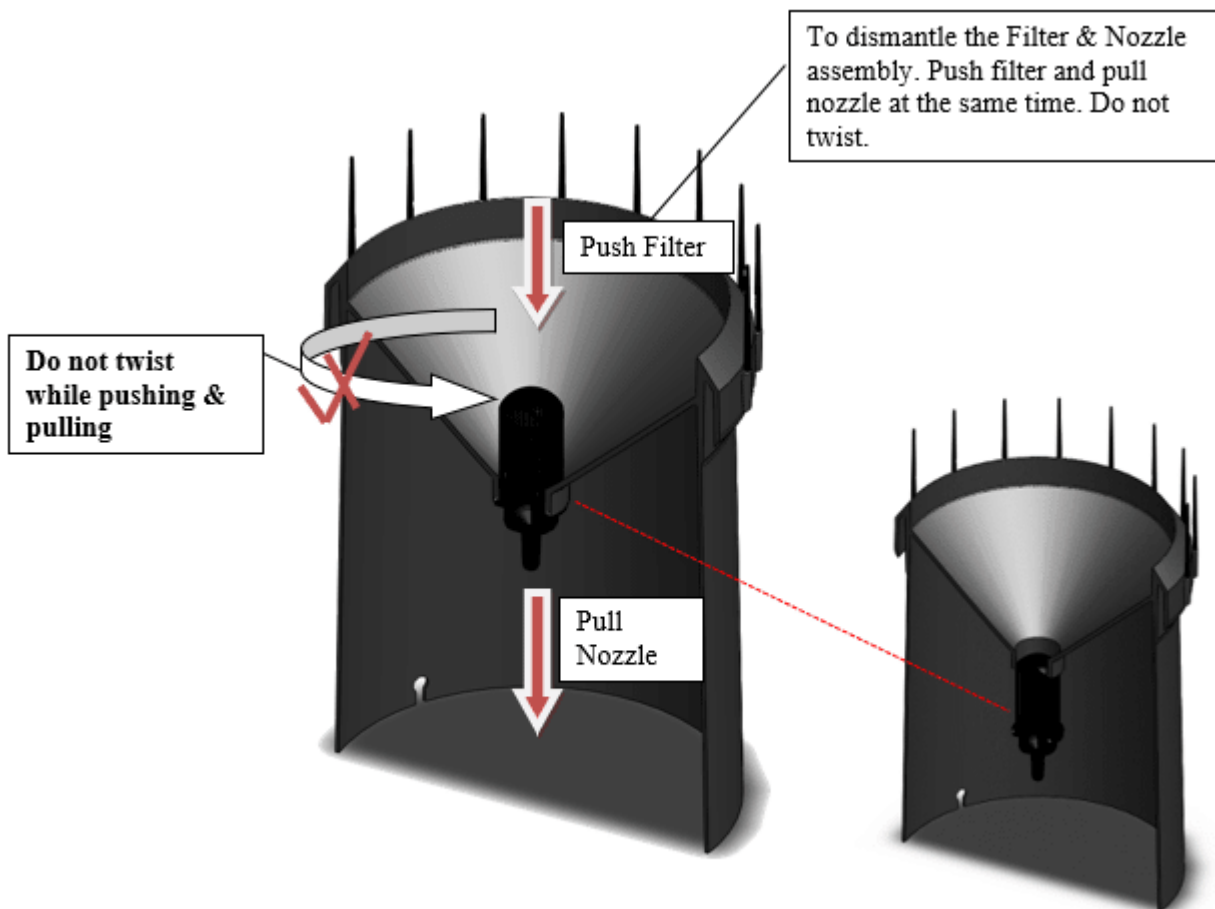

Diagram 4

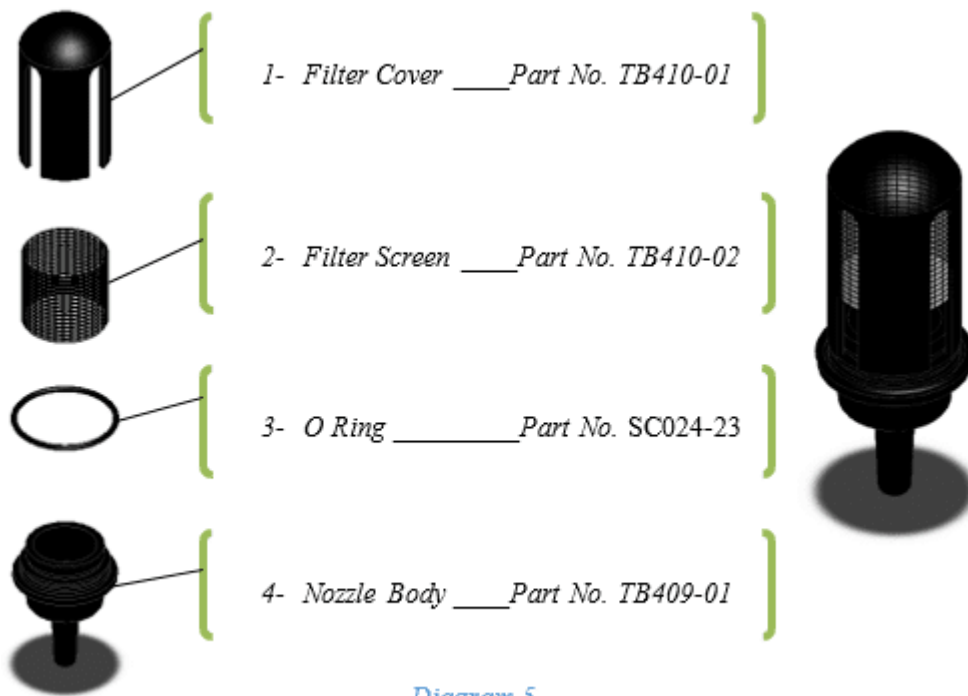

Diagram 5

Assembly Details

- Assemble filter to straight through Nozzle body
- Push assembly into funnel

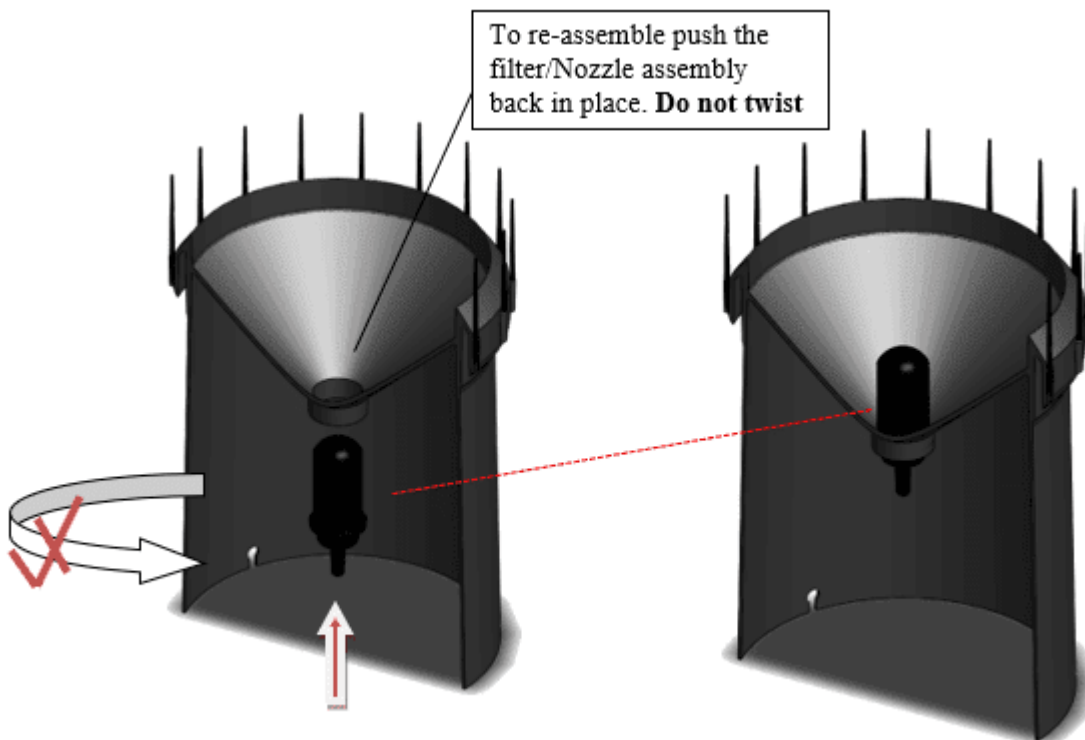

Diagram 6

6 Troubleshooting

KISTERS TB7 tipping bucket rain gauges (TBRG) are commonly used to measure rainfall by capturing water in a small bucket that tips once a certain amount of water has accumulated, sending a signal to a data logger or other recording device.

If the troubleshooting steps do not resolve the issue, contact KISTERS or the re-seller for support. Customer support may recommend additional diagnostic steps or be able to offer repairs or replacements.

Issue	Possible Cause	Solution
No tips recorded	Debris blockage, reed switch failure, no signal	Clean debris, test switch, check connections
Tips recorded too frequently	Faulty switch, bucket imbalanced, vibrations	Replace switch, check level, reduce vibrations
Rainfall measurement too low	Calibration issue, blockage, evaporation, freezing	Recalibrate, clear blockage, adjust for temperature
Rainfall measurement too high	Miscalibration, false tipping from wind or vibrations	Recalibrate, install wind shield, check for mechanical measures to reduce vibrations (damping)
Evaporation reducing rainfall totals	High temperatures, inappropriate bucket resolution	Switch to more a bucket resolution that is better adapted to high temperatures
Freezing or snow collecting in the funnel	Temperatures below roughly 4 °C (32.9 °F)	Consider deploying a KISTERS TB3 rain gauge with an optional heater
Data not recording	Connection issue, faulty logger	Check cables, reset/reboot logger, check settings

Installation and Environmental Issues

- **Levelling:** Ensure the rain gauge is properly levelled. If it's tilted, it could affect the accuracy of the tipping mechanism. Please use the level integrated in the TB7 base to properly align the rain gauge. The KISTERS Pole Mount Bracket allows for easy installation on externally threaded 2" poles. The provided nuts and bolts make levelling an easy task.
- **Open outlets:** Collected water is evacuated with each tip. Make sure that the 2 outlets at the bottom are free of any obstructions to allow for smooth and fast evacuation of collected rain water.
- **Installation Site:**
 - **Distance:** Rain gauges must be installed at a min distance of 2 times the height of the nearest natural or man-made obstacle. For each monitoring site, it is recommended to check the surroundings to make sure the above conditions is still met (trees grow, buildings or walls have been erected, ...).
 - **Sources of Debris:** Installation site as free of trees and bushes as possible. Leaves can lead to clogging even with a KISTERS TB7 that is equipped with a finger filter (better than any flat filter). Other sources of debris (including dust) that should be avoided or do require more frequent maintenance: landfills, extraction sites, quarries, industrial plants releasing dust particles into the air, etc.
 - **Vibration or Movement:** If the rain gauge is installed in a location that experiences vibration (from nearby machinery, for example), this could cause inaccurate tipping.
- **Environmental Factors**
 - **Wind Effects:** High winds can cause the bucket to tip prematurely or inaccurately. If you are in a particularly windy area, consider installing a wind shield or protective barrier around the rain gauge.
 - **Temperature:**
 - **Freezing:** Water can freeze in the funnel or bucket of the rain gauge when temperatures drop below 4 °C (39.2 °F). This can block the tipping mechanism, cause the gauge to under-report rainfall, or damage the gauge over time. Consider deploying a KISTERS TB3 rain gauge with an optional heater - contact the local re-seller for details. A heater will prevent water from freezing inside the funnel or bucket. In addition, heating can be used to melt down snow collected in the funnel: measures the water content equivalent of the collected snow.
 - **Evaporation:** During periods of high temperature, water collected in the funnel or bucket can evaporate before the tipping mechanism is triggered. This can result in under-reporting of rainfall, especially in dry, hot climates. Ensure

that the tipping bucket's resolution (amount of rain required to tip the bucket) is appropriate for local temperature conditions. Note that the funnel of a KISTERS TB7 is designed as to minimize evaporation by reducing the exposed surface area of the water.

Check for Physical Obstructions

- **Debris Blockage:** Leaves, dirt, insects, or other debris may obstruct the rain collector or the tipping mechanism. Check the funnel, the bucket area, and the drainage hole for any blockages. Clean out the funnel and bucket if necessary.
- **Ice or Snow:** In cold weather, ice or snow can block the bucket from tipping. Ensure the system is free from frozen precipitation.
- **Insects or Spiders:** Sometimes insects may nest inside the tipping mechanism, causing it to malfunction. KISTERS TB7 are equipped with a finger filter, filter-protected ventilation holes and drainage holes, all of which are dimensioned to prevent insects from entering. However, there may be occasions when small insects get in and need to be removed. Check the sensitive parts regularly.

Test the Tipping Mechanism

- **Manual Tipping Test:** Gently tip the bucket manually to see if it moves freely and if the electrical contacts or magnetic switch trigger correctly.
- **Bucket Alignment:** Ensure the bucket is balanced and can tip freely without catching or dragging on any surface.
- **Magnet and Reed Switch:** The tipping action is detected by a reed switch and a magnet. Ensure the magnet (incorporated to the flip side of the bucket) is correctly placed and that the switch engages when the bucket tips.
 - **Dual Reed Switch:** KISTERS TB7 are equipped with two reed switches. In case once reed switch fails, try to connect to the other one. In addition, worn out reed switches should be replaced. Spare parts and repair services are available from KISTERS.

Check Electrical Connections

- **Loose or Corroded Wires:** Inspect all electrical connections for signs of corrosion, wear, or loose connections. Clean and secure all connections.
- **Signal Output Test:** Use a multimeter to check if the switch closes when the bucket tips. If there's no change in signal when tipping, the reed switch might be faulty.

Inspect the Housing

- **Cracks or Leaks:**
 - Inspect the bucket for any cracks or leaks, which can cause incorrect tipping.
 - Housing: Cracks or leaks in the funnel can allow water to escape before reaching the bucket.
- **Loose Screws:** Check for loose screws or other mechanical issues that could affect the operation of the bucket.

Calibration Issues

- **Calibration Test:** The gauge may need recalibration if it is not measuring rainfall accurately. To test calibration, we recommend using one of the optional KISTERS Field Calibration Devices (FCD). The FCD will simplify the calibration in a standardized and field-proven process that covers the following steps:
 - Step 1: Measure out a known quantity of water (e.g., 10 mm or 20 mm of rain equivalent).
 - Step 2: Slowly pour it into the gauge (ensure a steady flow), and count how many times the bucket tips.
 - Step 3: Compare the tips with the expected number (based on the calibration factor of the device).

Test Data Logger or Recording Device

- If the tipping mechanism seems to work correctly, but the data is not recording, check the logging device for issues such as software errors, connection issues, or memory capacity.
 - **Signal Reception:** Ensure the data logger or recording device is receiving signals from the tipping bucket.
 - **Logger input channel configuration:** Check the input channel configuration. KISTERS TB7 use a reed switch and need to be connected to a counter input on the data logger. The input channel must be properly configured – please check the manual/documentation provided by the data logger manufacturer for details.
 - **Engineering units:** Settings in the data logger must properly align with the selected/installed KISTERS TB7 model.

Metric units	KISTERS TB7 bucket resolution: 0.2 mm, 0.5 mm	<ul style="list-style-type: none"> ▪ TB7/0.2 for 0.2 mm ▪ TB7/0.5 for 0.5 mm
Imperial units	KISTERS TB7 bucket resolution 0.01 inch	<ul style="list-style-type: none"> ▪ TB7/0.01 for 0.01 inch

7 Repair

KISTERS precision instruments and data loggers are produced in quality-controlled processes. All KISTERS production and assembly sites in Australia, New Zealand and Europe are ISO 9001 certified. All equipment is factory tested and/or factory calibrated before it is shipped to the client. This ensures that KISTERS products perform to their fullest capacity when delivered.

Despite KISTERS most rigorous quality assurance (QA), malfunction may occur within or outside of the warranty period. In rare cases, a product may not be delivered in accordance with your order.

In such cases KISTERS' return and repair policy applies. For you as a customer, this means the following:

- Contact KISTERS using the Repair Request Form and the Declaration of Contamination made available online:

Region (Language)	Download Link
Asia-Pacific (English)	Repair Request Form (APAC) Declaration of Contamination (APAC)
Europe, the Middle East and Africa (English)	Repair Request Form (EMEA) Declaration of Contamination (EMEA)
Germany (German)	Repair Request Form (DE) Declaration of Contamination (DE)

In response you will receive a reference number that must be referenced on all further correspondence and on the freight documents accompanying your return shipment.

- Please provide as much information and/or clear instructions within the return paperwork. This will assist our test engineers with their diagnosis.
- Please do not ship the goods prior to obtaining the reference number. KISTERS will not reject any equipment that arrives without reference number; however, it may take us longer to process.

Custom requirements for items sent to KISTERS for warranty or non-warranty repairs: Check with your national customs/tax authorities for details, processes and paperwork regarding tax exempt return of products. Typically, special custom tariff codes are available (such as HS Code = 9802.00) that verify the item is being returned for repair and has no commercial value. Please note that the customs invoice / dispatch documents should also clearly state: "Goods being returned to manufacturer for repair - No Commercial value". It is mandatory to have any returned goods accompanied by a commercial invoice on headed paper. KISTERS reserves the right to charge the customer for time spent rectifying incorrect customs documents.

Note: Please ensure that your goods are packed carefully and securely. Damage that occurs during transit is not covered by our warranty and may be chargeable.

7.1 TB7 Part List



Note: The TB7 Rain Gauge is ordered with a synthetic ceramic-coated brass bucket for the 1 mm size bucket only or UV-stabilized, Teflon-impregnated, injection-moulded for the 0.2 mm, 0.5 mm, or 0.01" size bucket.

Rain Gauge Part No.	Rain Gauge Description
TB7/0.2	Tipping Bucket Rain Gauge, bucket capacity 0.2 mm, bucket type UV-stabilised, Teflon-impregnated, injection-moulded
TB7/0.01"	Tipping Bucket Rain Gauge, bucket capacity 0.01 inch, bucket type UV-stabilised, Teflon-impregnated, injection-moulded
TB7/0.5	Tipping Bucket Rain Gauge, bucket capacity 0.5 mm, bucket type UV-stabilised, Teflon-impregnated, injection-moulded

TB7 Base Part List



REFERENCE	PART_ID	DESCRIPTION	QTY_PER
1	TB701-01	BASE-INJECTION MOULDED	1
3	SC008-29	M5x0.8 SS304 HEX NUT	3
4	SC045-21	SOC HD CAPSCREW M5x0.8x12 SS304	3
5	TB301-05	PIVOT SCREW	2
6	TB301-06	PIVOT SCREW LOCK NUT	2
7	SC006-12	MINIATURE P CLIP #20-PTC 6.4B	1
8	SC022-114	6GA x 1/4 SELF TAPPING SCREW 304 PAN HD PHILLIPS	1

REFERENCE	PART_ID	DESCRIPTION	QTY_PER
		STAINLESS STEEL	
9	TB307	MODEL TB3 RAIN GAUGE REED SWITCH ASSEMBLY	0.5
10	SC023-09	BULL'S EYE LEVEL	1
11	SC100-09	SERIAL PLATE	1
12	SC100-06	CALIBRATED LABEL	1
13	SC040-58	SPFM10 10 MM FINNED SNAP IN PLUG BLACK	1
14	TB312	ADJUSTING SCREW ASSEMBLY	2
15	SC022-116	6GA x 1/2 SELF TAPPING SCREW 304 PAN HD PHILLIPS STAINLESS STEEL	2

TB7 Bucket Part List

16
 Part no: TB304/0.2P/TEF
 Descript: Bucket (0.2mm, 0.01")
 or
 Part no: TB304/0.5P/TEF
 Descript: Bucket (0.5mm)
 Quantity: 1

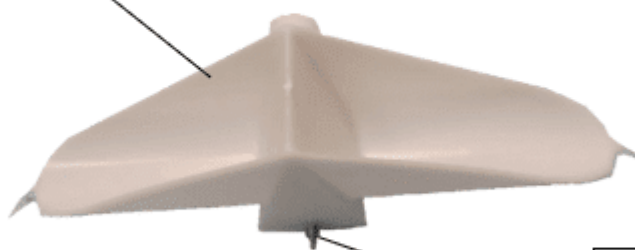

Teflon Impregnated UV
 stabilized Bucket

17
 Part no: TB304-03
 Descript: Bucket Axle
 Quantity: 1

Filter/Nozzle Part List

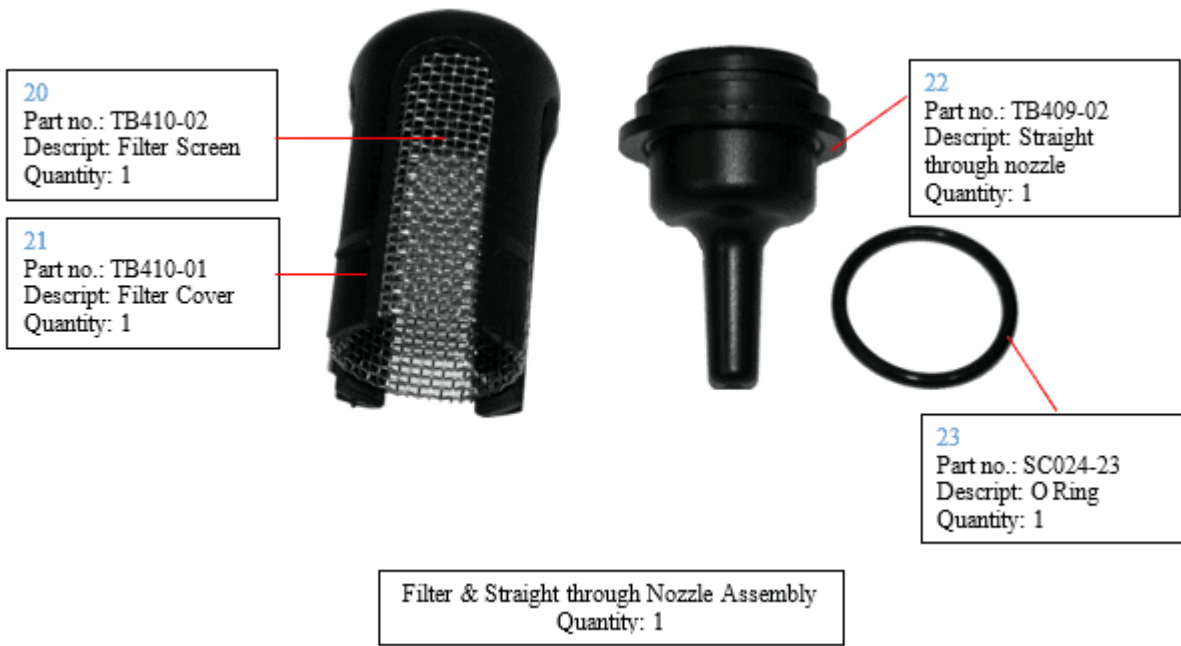

Enclosure Part List

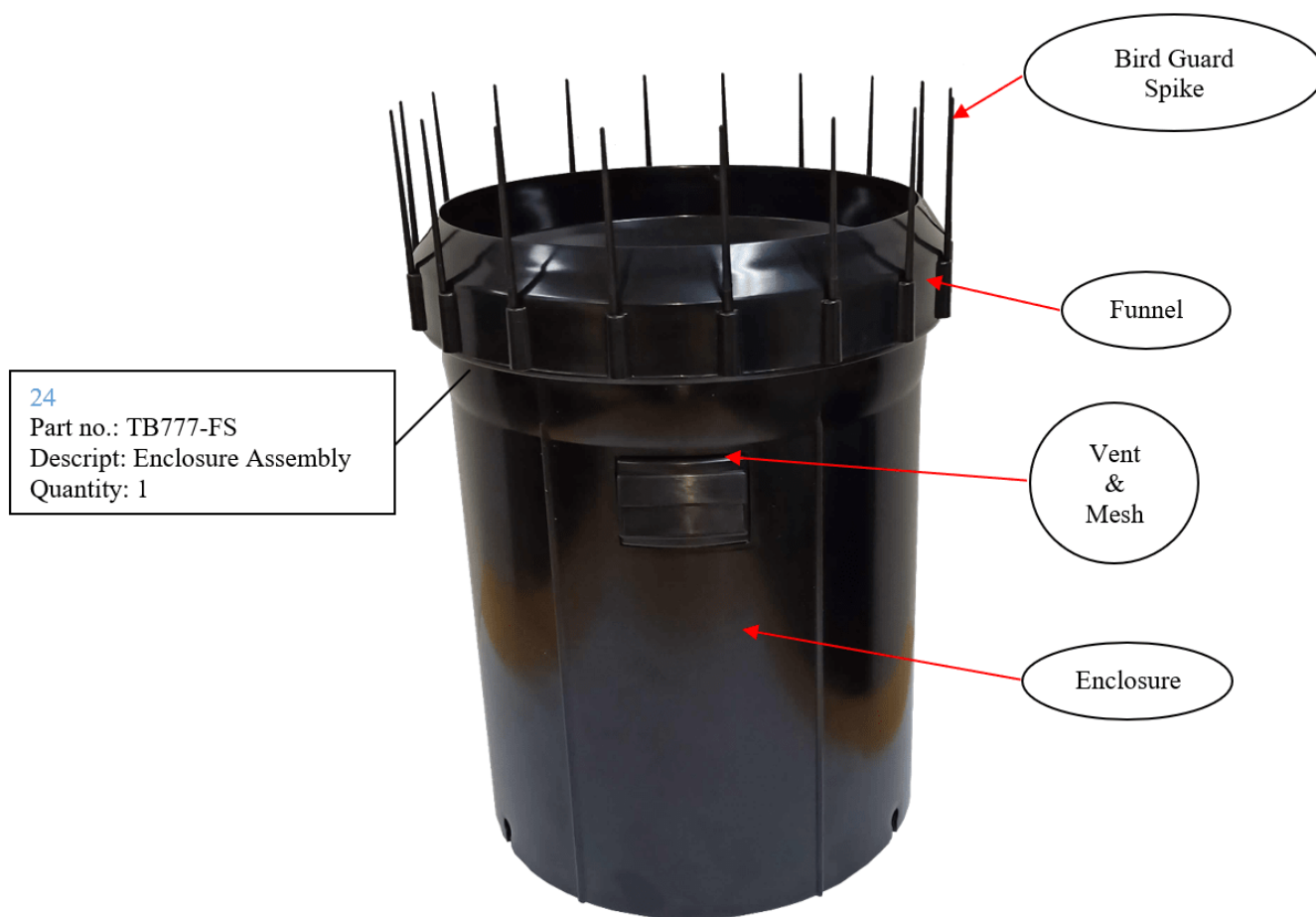

Part no.	Description	Quantity
TB777-FS	TB7 Enclosure and Funnel complete without bird guard spikes	1
TB418-06	Vent	1
TB408-05	Mesh	1
TB777-04	Bird Guard Spike	18 + 6 Spares

Table 1 - TB7 enclosure parts list

8 Technical Data

Resolution	0.2 mm, 0.5 mm, 1.0 mm, 0.01"			
Range	700 mm per hour			
Accuracy	Resolution			
		0.2 mm	0.01"	0.5 mm
	Flow rate 0 - 200 mm/h	±5%	±5%	±5%
	Flow rate 200 - 500 mm/h	NA	NA	better than -8%
	Alternatively: Individual accuracy ±2% at any set intensity specified by the user, calibration required Note: Additional costs for individually calibrated units			
Enclosure and Base	UV-resistant ASA			
Pivots	Ground sapphire pivots			
Bucket	<ul style="list-style-type: none"> ▪ Teflon-impregnated, injection-moulded ▪ Painted metal bucket (TB7/1.0 mm model only) 			
Dimensions	<ul style="list-style-type: none"> ▪ Height: 310 mm ▪ Catch: 200 mm diameter 			
Mass	2.1 kg			

9 Obligations of the Operator and Disposal

This chapter contains the following subsections:

- [Obligations of the Operator](#)^[24]
- [Dismantling / Disposal](#)^[24]

9.1 Obligations of the Operator

European Union

In the Single European Market it is the responsibility of the operator to ensure that the following legal regulations are observed and complied with: national implementation of the framework directive (89/391/EEC) and the associated individual directives, in particular 2009/104/EC, on minimum safety and health requirements for the use of work equipment by employees at work.

Worldwide

Regulations: If and where required, operating licences must be obtained by the operator. In addition, national or regional environmental protection requirements must be complied with, regardless of local legal provisions regarding the following topics:

- Occupational safety
- Product disposal

Connections: Local regulations for electrical installation and connections must be observed.

9.2 Dismantling / Disposal

When disposing of the units and their accessories, the applicable local regulations regarding environment, disposal and occupational safety must be observed.

Before dismantling

- Electrical Devices:
 - Switch off the units.
 - Disconnect electrical appliances from the power supply, regardless of whether the appliances are connected to the mains or to another power source.
- Mechanical devices:
 - Fix all loose components. Prevent the device from moving independently or unintentionally.
 - Loosen mechanical fastenings: Please note that appliances can be heavy and that loosening the fastenings may cause them to become mechanically unstable.

Disposal

Operators of old appliances must recycle them separately from unsorted municipal waste. This applies in particular to electrical waste and old electronic equipment.

Electrical waste and electronic equipment must not be disposed of as household waste!

Instead, these old appliances must be collected separately and disposed of via the local collection and return systems.

Integrated or provided batteries and accumulators must be separated from the appliances and disposed of at the designated

collection point. At the end of its service life, the lithium-ion battery must be disposed of according to legal provisions.

EU WEEE Directive













As players in the environmental market, KISTERS AG is committed to supporting efforts to avoid and recycle waste. Please consider:

- Avoidance before recycling!
- Recycling before disposal!



This symbol  indicates that the scrapping of the unit must be carried out in accordance with Directive 2012/19/EU. Please observe the local implementation of the directive and any accompanying or supplementary laws and regulations.

Contact Data

Europe	KISTERS Europe	 +49 2408 9385 0
		 hydromet.sales@kisters.eu
		 www.kisters.eu
Australia	KISTERS Australia	 +612 9601 2022
		 sales@kisters.com.au
		 www.kisters.com.au
New Zealand	KISTERS New Zealand	 +64 7 857 0810
		 sales@kisters.co.nz
		 www.kisters.co.nz
Latin America	KISTERS Latin America	 +57 350 575 4079
		 sales@kisters-latam.com
		 www.kisters-latam.com
North America	KISTERS North America	 +1 561 459 4876
		 kna@kisters.net
		 www.kisters.net
Spain	KISTERS Ibérica	 info@kisters.es
		 www.kisters.es
France	KISTERS France	 +33 1 4120 9200
		 info@kisters.fr
		 www.kisters.fr

